

Ersatzteilliste Gas-Gebläsebrenner  
Spare part list Gas burner  
Vue éclatée Brûleur gaz  
N 10.12000 G-E

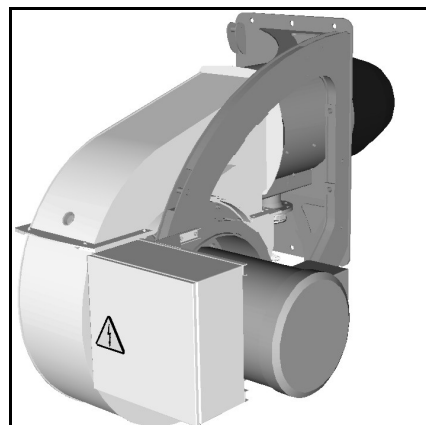

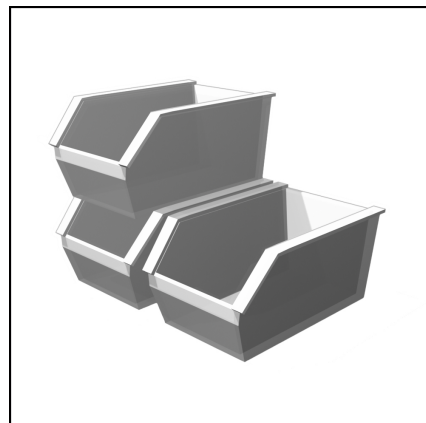



---

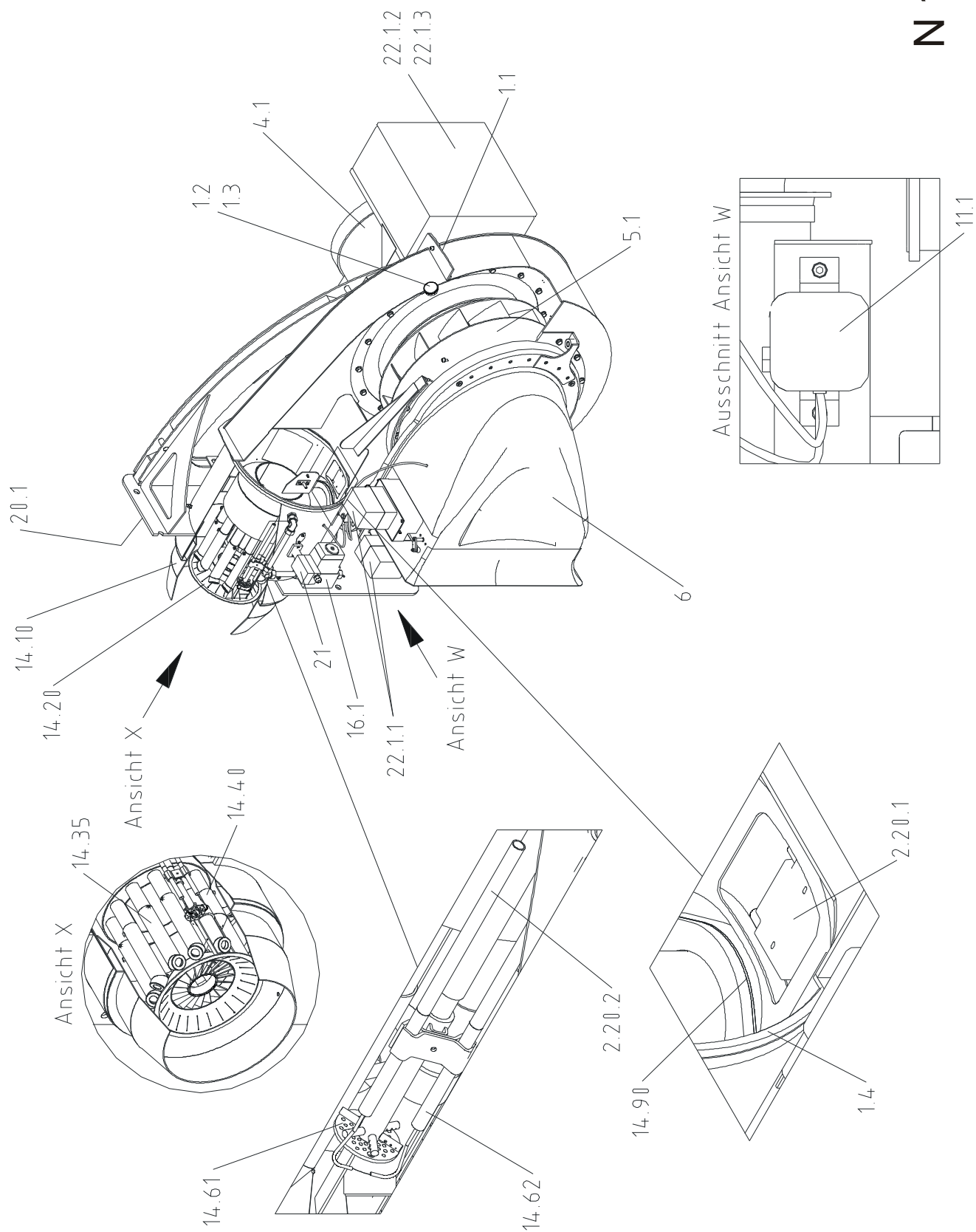





# elco





# N 10 G-E



	<b>Pos.</b>	<b>Bezeichnung</b>		<b>Artikel-Nr.</b>
	<b>Pos.</b>	<b>Description</b>		<b>Article-No.</b>
	<b>Pos.</b>	<b>Description</b>		<b>Nr. articles</b>
<b>Baugruppe:</b>	1	Grundausstattung	10 G-R/G-E	
<b>Ass.group:</b>		Basis equipment		
<b>Ensemble:</b>		Equipement de base		
	1.1	Zellkautschukstreifen Linkage ass. cover Profil en plastique	12 x 3	333.311.5453
	1.2	Schauglas Sight glass Regard	55x21	118.060.3227 
	1.3	Schauglasdeckel Sight glass cover Couvercle pour regard	D 55	118.805.2260 
	1.4	Dichtung (Profil) seal Joint	D 15	578.883.8175 
<b>Baugruppe:</b>	2.20.1	Zündtrafo	EBI 4 2POLIG	140.378.30
<b>Ass.group:</b>		Ignition transformer		
<b>Ensemble:</b>		Transformateur d'allumage		
<b>Baugruppe:</b>	2.20.2	Zündkabel	1500 mm	172.877.7751
<b>Ass.group:</b>		Ignition lead		
<b>Ensemble:</b>		Câble d'allumage		
<b>Baugruppe:</b>	4	Motor BG LP	400/690V	
<b>Ass.group:</b>		Motor ass.		
<b>Ensemble:</b>		Moteur		
	4.1	Motor Motor Moteur	MOTOR 30,0KW 3000/MIN 400/690V 50	140.550.78 
<b>Baugruppe:</b>	opt. 4	Motor BG MP	400/690V	
<b>Ass.group:</b>		Motor ass.		
<b>Ensemble:</b>		Moteur		
	4.1	Motor Motor Moteur	MOTOR 37,0KW 3000/MIN 400/690V 50	140.550.67 
<b>Baugruppe:</b>	opt. 4	Motor BG HP	400/690V	
<b>Ass.group:</b>		Motor ass.		
<b>Ensemble:</b>		Moteur		
	4.1	Motor Motor Moteur	MOTOR 45,0KW 3000/MIN 400/690V 50	140.550.56 
<b>Baugruppe:</b>	5	Ventilatorrad BG LP		
<b>Ass.group:</b>		Air fan ass.		
<b>Ensemble:</b>		Turbine		
	5.1	Ventilatorrad Air fan Turbine	D 675/90	124.885.8413

	<b>Pos. Pos. Pos.</b>	<b>Bezeichnung Description Description</b>		<b>Artikel-Nr. Article-No. Nr. articles</b>
<b>Baugruppe:</b>	opt. 5	Ventilatorrad BG MP		
<b>Ass.group:</b>		Air fan ass.		
<b>Ensemble:</b>		Turbine		
	5.1	Ventilatorrad Air fan Turbine	D 680/93	124.885.6791
<b>Baugruppe:</b>	opt. 5	Ventilatorrad BG HP		
<b>Ass.group:</b>		Air fan ass.		
<b>Ensemble:</b>		Turbine		
	5.1	Ventilatorrad Air fan Turbine	D690/100	124.883.7730
<b>Baugruppe:</b>	6	Luftansaugkasten kpl.	STAHL RAL7035	140.342.44
<b>Ass.group:</b>		Air intake housing cpl.		
<b>Ensemble:</b>		Boîte à air cpl.		
<b>Baugruppe:</b>	11	Druckwächter BG	DL 50 A	
<b>Ass.group:</b>		Pressure switch		
<b>Ensemble:</b>		Pressostat différentiel		
	11.1	Luftdruckwächter Air pressure switch Pressostat air	DL 50A 2,5-50 mbar	333.312.3039
<b>Baugruppe:</b>	14	Lanzengaskopf Grundl.	10.12000 G-E	
<b>Ass.group:</b>		Lanee gas head basis ext.		
<b>Ensemble:</b>		Tête gaz multijet		
	14.10	Flammenrohr Flame tube Gueulard	10.12000 GL D369/497X425	140.100.99 
	14.20	Stauscheibe Brake plate Accrocheur	D306/74 BEF.250MM 45°	140.100.66 
	14.35	Gasdüse Gas nozzle Injecteur gaz	D40/ 22 x 195	140.100.77
	14.40	Gasdüse (Innendüse) Gas nozzle Injecteur gaz	D40/ 8 x 167	140.100.88
	14.60	Zündbrenner BG Ignition burner Pilote d'allumage	ZB 2	168.877.7762 
	14.61	- Zündbrenner Ignition burner Pilote d'allumage	ZB 2	168.829.4017 
	14.62	- Zündelektrode Ignition electrode Électrode d'allumage	D11x100x85mm	172.874.2005 
	14.90	Dichtung Ovalflansch Seal Joint	DN100	196.882.7383 

	<b>Pos. Pos. Pos.</b>	<b>Bezeichnung Description Description</b>		<b>Artikel-Nr. Article-No. Nr. articles</b>
<b>Baugruppe:</b>	16	Zündgaskompaktarmatur BG	R1/2Z EK7-9	
<b>Ass.group:</b>		Ignition gas armature ass.		
<b>Ensemble:</b>		Robinetterie d'allumage		
	16.1	Zündgaskompaktarmatur Ignition gas armature Robinetterie d'allumage	CG15 R03D1-50W6	147.879.7282
	16.2	Kugelhahn Ball valve Vanne à boisseau	R 1/2Z BAUL.DIN3202-M3	120.005.11
<b>Baugruppe:</b>	20	Beipack	10	
<b>Ass.group:</b>		Accessory		
<b>Ensemble:</b>		Accessoires		
	20.1	Isoglasband, weiß glas insulating tape bande isolante	B=30	496.873.6069
<b>Baugruppe:</b>	21	Überwachungsbaugruppe	10 G/GL (RU/EU)	
<b>Ass.group:</b>		Flame monitor system		
<b>Ensemble:</b>		Le contrôle de flamme		
	21.1	Flammenfühler Flame sensor Sonde de flamme	FFS 06 UV	175.884.3743 
	21.1 A	Flammenfühler Flame sensor Sonde de flamme	QRA 53 E	140.486.32 
	21.1 B	Flammenfühler Flame sensor Sonde de flamme	QRA 2	175.810.6258 
<b>Baugruppe:</b>	22	Elektroausstattung	10 G	
<b>Ass.group:</b>		Electric equipment		
<b>Ensemble:</b>		Electric montage en saillie		
	22.1 A	Elektromodul/BCS Gasbrenner Electric ass. Electric ass.	BCS-300	171.885.4911
	22.1.1	- Stellantrieb Actuator Servo-moteur	SAD 15.0	121.879.0509
	22.1.2	- Flammenwächter Flame detector Le détecteur de flamme	BCS-FLW 05	175.879.5195
	22.1.3	- BCS-Grundmodul BCS-basic module BCS-module base	BCS 300	175.879.1079
	22.1 B	Elektromodul / Etamatic Gasbrenner Electric ass. Electric ass.	Lamtec EVR	171.884.5669
	22.1.1	- Stellantrieb Actuator Servo-moteur	STM 30/40 Q15	121.879.0510
	22.1.2	- Etamatic OEM Grundgerät Electric ass. Electric ass.		175.884.3765

---

**Ausstattung:** Die Gasklappe ist kommissionsbezogen zu bestellen.

**Equipment:** The gas valve as ordered for commission specification.

**Accessoires:** Le registre gaz doit être commandé en fonction de l'installation.

Weitere Teile auf Anfrage.  
Further spare part on request.  
Autres pièces détachées sur demande.



Hilfsmaterial  
Auxiliary material  
Matériau auxiliaire



Verschleißteile  
Wear parts  
Pièces d'usure

**Revision**

Änderungen im Sinne der technischen Weiterentwicklung vorbehalten.  
Modifications to incorporate latest technical developments are reserved.  
Sous réserve de modifications résultant du perfectionnement technique.

Kundendienst: Service: Votre service après-vente:
---

К О Н Т А К Т Ы
-----------------

Distributor in Russia "Teplopartner" LTD Russia, Krasnodar city, Stasova street, 184, office 4 Tel./fax.: 8 (861) 234 23 83, +7 (961) 854 41 24 www.gorelka-kotel.ru info@gorelka-kotel.ru
---

ELCO GmbH  
D-64546 Mörfelden-Walldorf

ELCO Austria GmbH  
A - 2544 Leobersdorf

ELCOTHERM AG  
CH - 7324 Vilters

ELCO Rendamax B.V.  
NL - 1410 AB Naarden

ELCO Belgium n.v./s.a.  
B - 1731 Zellik

ELCO Italia S.p.A  
I - 31023 Resana (TV)